

GA3000

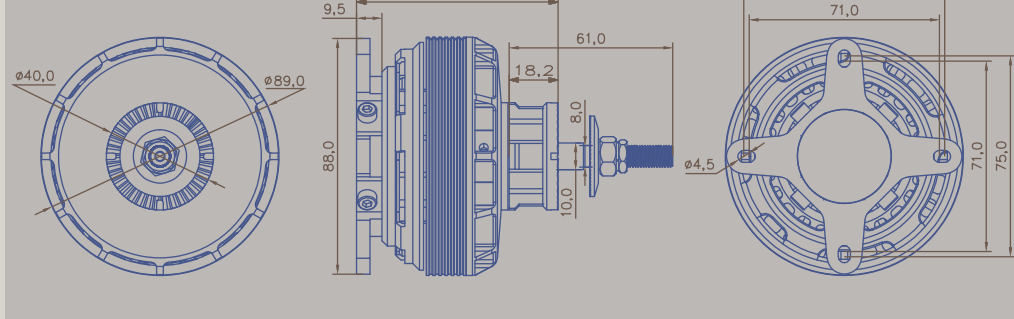

Specification

2nd Generation GA Series	GA3000.5	GA3000.7	GA3000.10
Item NO. (商品编号)	51550	51551	51555
RPM/V (KV值)	380 RPM/V	270 RPM/V	180 RPM/V
Weight w/o accessories (不含配件重量)	585g	585g	585g
Outer Diameter (直径)	89mm	89mm	89mm
Length w/ mounts (长度(带桨座))	75.2mm	75.2mm	75.2mm
Length(overall)(长度)	118mm	118mm	118mm
Diameter of Shaft (轴径)	12mm(internal), 8mm(output)	12mm(internal), 8mm(output)	12mm(internal), 8mm(output)
Mounting holes pitch (安装孔距)	71mm to 75mm	71mm to 75mm	71mm to 75mm
Slots,Poles (槽数, 极数)	24, 28	24, 28	24, 28
Idle Current(Io) @10V (空载电流)	2.8A	1.8A	1.1A
Resistance(Ri) (电阻)	9.5mOhm	17.3mOhm	36mOhm
Nominal Voltage(V) (额定电压)	22.2V, 6S Lipo	29.6V, 8S Lipo	44.4V, 12S Lipo
Peak power[15s] (峰值功率)	2900W	3000W@	3300W@
Bursts current[15s] (最大电流)	130A	100A	75A
Cruising power[8 mins] (巡航功率)	1500W	1600W	1700W
Recommended ESC (调速器)	Ultra 1500 amps	XC13036HV	XC10036HV
Propeller (螺旋桨配置)	19x10 (9.3KG,120A) 20x10 (10KG, 130A)	18x10, 19x10, 20x10	18x10, 19x10, 20x10
Weight of sports airplane (运动飞机的重量)	Up to 7.5kg	Up to 7.5kg	Up to 8kg
Weight of 3D airplane (3D飞机的重量)	Up to 5.0kg	Up to 5.0kg	Up to 5.5kg
Applications (应用)	For 120E to 140E class 3D airplane (upto 74" wingspan)	For 120E to 140E class 3D airplane (upto 74" wingspan)	For 120E to 140E class 3D airplane (upto 74" wingspan)

GA3000.5 (380KV)

Motor @ Optimum Efficiency

最佳效率

Current(电流):	101.09A
Voltage(电压):	20.27V
Revolutions(转速):	7064rpm
Electric Power(输入功率):	2049.1W
Mech. Power(输出功率):	1839.5W
Efficiency(效率):	89.8%

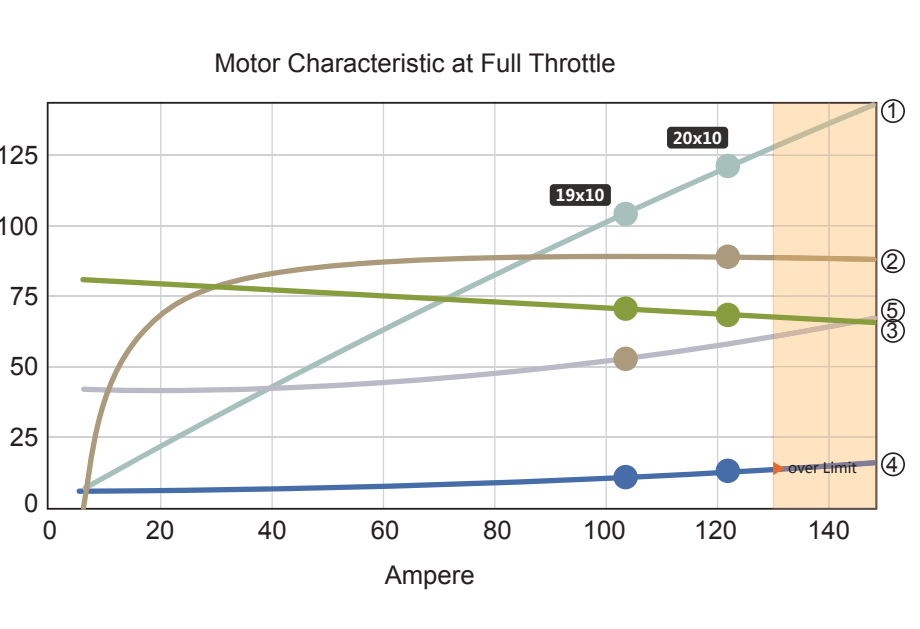
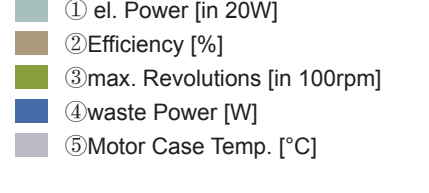

Voltage (V)	Propeller	Propeller (RPM)	Throttle (%)	Current (DC) (A)	Volage (DC) (V)	el. Power (W)	Efficiency (%)	Thrust (g)	Spec. Thrust (g/W)
22.2V (6S LIPO)	19x10	1500	19	1.3	22.2	28.5	66.8	418	14.6
		2000	25	2.7	22.2	58.5	76.9	735	12.6
		2500	32	4.9	22.1	106.9	82.5	1153	10.8
		3000	38	8.1	22.1	177.7	85.7	1661	9.3
		3500	45	12.6	22	276.1	87.6	2261	8.2
		4000	52	18.7	21.9	406.7	88.8	2953	7.3
		4500	59	26.6	21.8	574.5	89.5	3737	6.5
		5000	66	36.7	21.6	784.5	89.9	4614	5.9
		5500	74	49.2	21.4	1041.7	90.1	5583	5.4
	6000	82	64.7	21.1	1351.2	90.2	6644	4.9	
	6500	91	83.6	20.8	1718.3	90.2	7798	4.5	
	6999	100	107	20.4	2156.2	89.8	9040	4.2	
	20x10	1500	19	1.5	22.2	33	70.8	484	14.7
		2000	25	3.2	22.1	69.4	79.8	861	12.4
		2500	32	5.8	22.1	128	84.5	1345	10.5
		3000	38	9.8	22	214.6	87.2	1937	9
		3500	45	15.4	21.9	335	88.7	2637	7.9
		4000	52	22.9	21.8	495.3	89.5	3444	7
4500		60	32.7	21.7	701.8	89.9	4359	6.2	
5000		67	45.3	21.4	960.5	90.1	5381	5.6	
5500		76	61.1	21.2	1277.9	90.2	6512	5.1	
6000	84	80.7	20.8	1660.4	90.1	7749	4.7		
6500	94	104.9	20.4	2114.6	90	9095	4.3		
6814	100	123.7	20.1	2453.1	89.5	9995	4.1		

GA3000.7 (270KV)

Motor @ Optimum Efficiency

最佳效率

Current(电流):	76.87A
Voltage(电压):	27.7V
Revolutions(转速):	6854rpm
Electric Power(输入功率):	2129.3W
Mech. Power(输出功率):	1909.1W
Efficiency(效率):	89.7%

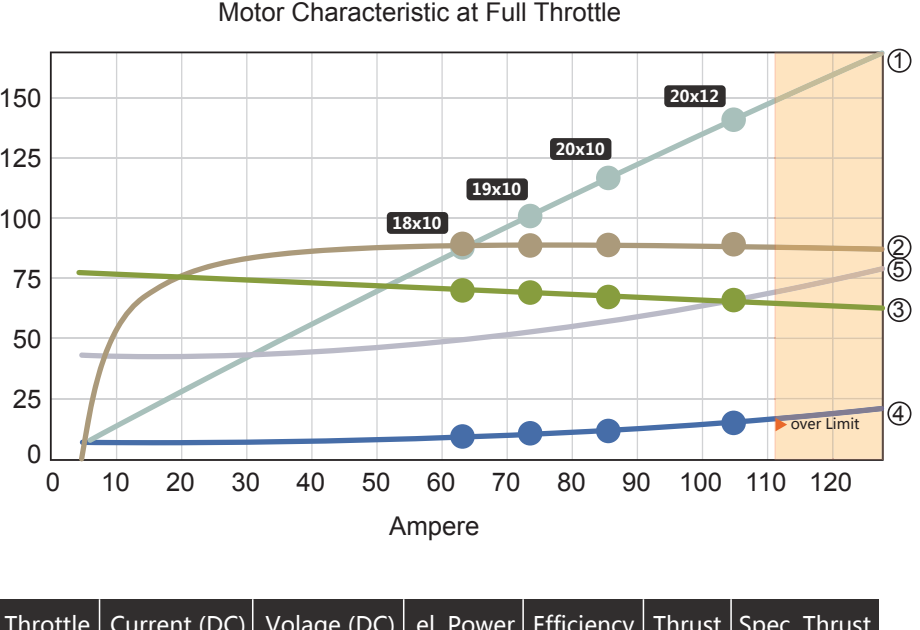
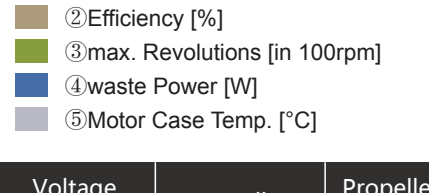

Voltage (V)	Propeller	Propeller (RPM)	Throttle (%)	Current (DC) (A)	Volage (DC) (V)	el. Power (W)	Efficiency (%)	Thrust (g)	Spec. Thrust (g/W)
28.6V (8S LIPO)	18x10	1500	20	0.8	29.6	24.9	61.6	353	14.2
		2000	26	1.7	29.6	50	72.8	628	12.6
		2500	33	3	29.5	89.6	79.3	981	11
		3000	40	5	29.5	147.5	83.2	1412	9.6
		3500	47	7.8	29.4	227.5	85.6	1922	8.4
		4000	54	11.4	29.3	333.5	87.2	2511	7.5
		4500	61	16.1	29.2	469.5	88.2	3178	6.8
		5000	68	22	29.1	639.2	88.9	3923	6.1
		5500	76	29.4	28.9	846.9	89.3	4747	5.6
		6000	83	38.3	28.7	1096.3	89.5	5649	5.2
		6500	91	49.1	28.5	1391.7	89.7	6630	4.8
		7000	100	61.9	28.2	1737.2	89.7	7689	4.4
	7021	100	62.6	28.2	1756	89.4	7736	4.4	
	19x10	1500	20	1	29.6	28.7	66.3	415	14.5
		2000	26	2	29.6	59.1	76.4	738	12.5
		2500	33	3.6	29.5	107.4	82.1	1153	10.7
		3000	40	6.1	29.5	178.5	85.4	1661	9.3
		3500	47	9.5	29.4	277	87.3	2261	8.2
		4000	54	14	29.3	407.9	88.5	2953	7.2
		4500	61	19.8	29.2	576	89.3	3737	6.5
		5000	69	27.2	29	786.3	89.7	4614	5.9
		5500	77	36.4	28.8	1043.8	89.9	5583	5.3
		6000	85	47.3	28.5	1353.6	90	6644	4.9
		6500	93	61.3	28.2	1720.8	90	7798	4.5
		6888	100	74	27.9	2055.5	89.6	8755	4.3
	20x10	1500	20	1.1	29.6	33.2	70.3	484	14.6
		2000	27	2.4	29.5	69.8	79.4	861	12.3
		2500	33	4.4	29.5	128.5	84.2	1345	10.5
		3000	40	7.3	29.4	215.1	86.9	1937	9
		3500	47	11.5	29.3	335.7	88.5	2637	7.9
		4000	55	17.1	29.2	496.1	89.4	3444	6.9
		4500	62	24.3	29.1	702.5	89.8	4359	6.2
		5000	70	33.5	28.8	961.1	90.1	5381	5.6
		5500	78	45	28.6	1278.2	90.2	6512	5.1
		6000	86	59.1	28.3	1660.2	90.1	7749	4.7
		6500	95	76.3	27.9	2113.5	90	9095	4.3
6743		100	86.4	27.7	2373.1	89.6	9787	4.1	
20x12	1500	20	1.4	29.6	41.4	75.4	581	14.1	
	2000	27	3	29.5	89.2	82.8	1033	11.6	
	2500	34	5.7	29.5	166.7	86.5	1614	9.7	
	3000	41	9.6	29.4	281.9	88.5	2325	8.2	
	3500	48	15.2	29.3	442.7	89.4	3164	7.1	
	4000	56	22.7	29.1	657.4	89.9	4133	6.3	
	4500	63	32.6	28.9	934.4	90.1	5231	5.6	
	5000	72	45.2	28.6	1282.2	90	6458	5	
	5500	80	61	28.2	1709.7	89.9	7814	4.6	
	6000	90	80.8	27.8	2225.7	89.6	9299	4.2	
	6500	100	105.2	27.2	2839.7	89.3	10914	3.8	
	6509	100	106.4	27.2	2869.9	88.9	10945	3.8	

GA3000.10 (180KV)

Motor @ Optimum Efficiency

最佳效率

Current(电流):	72.54A
Voltage(电压):	40.58V
Revolutions(转速):	6712rpm
Electric Power(输入功率):	2943.4W
Mech. Power(输出功率):	2657W
Efficiency(效率):	90.3%

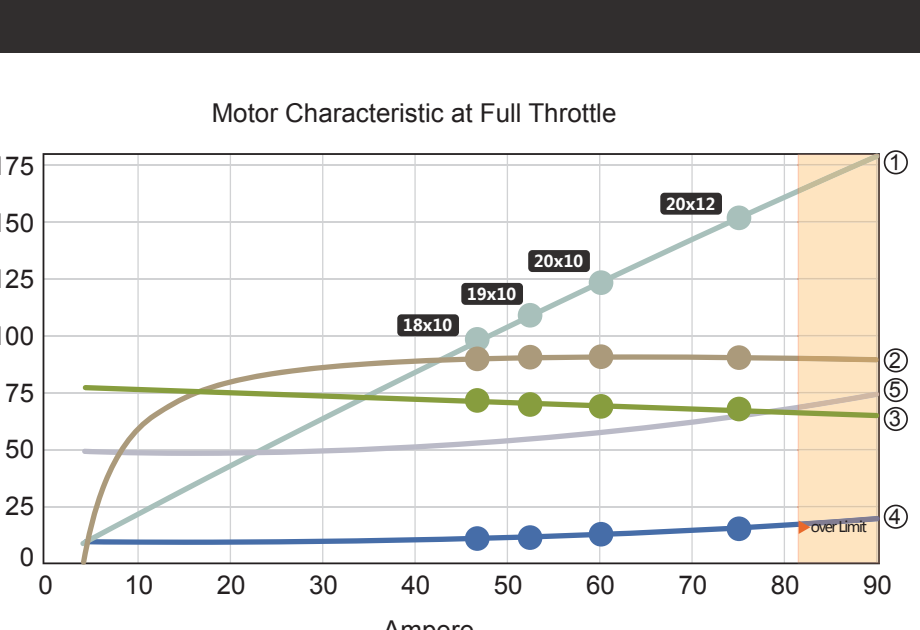
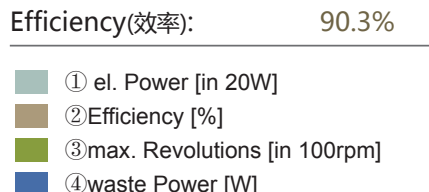

Voltage (V)	Propeller	Propeller (RPM)	Throttle (%)	Current (DC) (A)	Volage (DC) (V)	el. Power (W)	Efficiency (%)	Thrust (g)	Spec. Thrust (g/W)
44.4V (12S LIPO)	18x10	1500	20	0.6	44.4	27.4	55.9	353	12.9
		2000	26	1.2	44.3	53.4	68.1	628	11.8
		2500	33	2.1	44.3	95.5	75.2	941	10.4
		3000	39	3.5	44.2	153	80.2	1412	9.2
		3500	46	5.3	44.1	234.3	83.2	1922	8.2
		4000	53	7.8	44	341.6	85.2	2511	7.4
		4500	60	10.9	43.8	478.8	86.5	3178	6.6
		5000	67	14.9	43.6	649.8	87.4	3923	6
		5500	75	19.8	43.4	858.6	88.1	4747	5.5
		6000	82	25.8	43.1	1109.1	88.5	5649	4.7
		6500	90	33	42.7	1405.3	88.8	6630	4.1
		7000	98	41.5	42.3	1751.1	89	7689	4.4
	7125	100	43.7	42.2	1839.7	88.7	7967	4.3	
	19x10	1500	20	0.7	44.4	31.2	61	415	13.3
		2000	26	1.4	44.3	62.4	72.3	738	11.8
		2500	33	2.5	44.3	111.6	79	1153	10.3
		3000	40	4.2	44.2	183.6	83	1661	9
		3500	46	6.4	44.1	283	85.5	2261	8
		4000	53	9.5	43.9	414.6	87.1	2953	7.1
		4500	61	13.4	43.7	583.1	88.2	3737	6.4
		4500	61	13.4	43.7	583.1	88.2	3737	6.4
		5500	75	24.4	43.2	1050.7	89.3	5583	5.3
		6000	83	31.8	42.8	1359.5	89.6	6644	4.9
		6500	91	40.7	42.3	1724.9	89.8	7798	4.5
		7000	100	51.6	41.8	2152	89.9	9043	4.2
	20x10	1500	20	0.8	44.4	35.7	65.6	484	13.6
		2000	26	1.6	44.3	73	75.9	861	11.8
		2500	33						