



HUBSAN X4 CAM PLUS

2.4GHZ RC SERIES 4 CHANNEL



FCC Information

This equipment has been tested and found to comply with the limits for a Class B digital device, pursuant to Part 15 of the FCC Rules. These limits are designed to provide reasonable protection against harmful interference in a residential installation. This equipment generates, uses and can radiate radio frequency energy and, if not installed and used in accordance with the instructions, may cause harmful interference to radio communications. However, there is no guarantee that interference will not occur in a particular installation. If this equipment does cause harmful interference to radio or television reception, which can be determined by turning the equipment off and on, the user is encouraged to try to correct the interference by one or more of the following measures:

- Reorient or relocate the receiving antenna.
- Increase the separation between the equipment and receiver.
- Connect the equipment into an outlet on a circuit different from that to which the receiver is connected.
- Consult the local dealer or an experienced radio/TV technician for help.

Changes or modifications not expressly approved by the party responsible for compliance could void the user's authority to operate the equipment.

This device complies with Part 15 of the FCC Rules. Operation is subject to the following two conditions: (1) this device may not cause harmful interference, and (2) this device must accept any interference received, including interference that may cause undesired operation.

CATALOGUE

INTRODUCTION	02
SAFETY NOTES	02
SAFETY CHECKS BEFORE FLYING	04
CHARGING THE LiPo BATTERY	05
TRANSMITTER	06
CAMERA RECORDING	09
FLY THE X4	10
ADVANCED PERFORMANCE SETUP	13
REPLACING PROPELLERS	17
EXPLODED VIEW	18
H107C+ TROUBLESHOOTING	20
SPARE PART CHART	23

Electrical and electronic equipment that are supplied with batteries (including internal batteries)

WEEE Directive & Product Disposal

At the end of its serviceable life, this product should not be treated as household or general waste. It should be handed over to the applicable collection point for the recycling of electrical and electronic equipment, or returned to the supplier for disposal.

Internal / Supplied Batteries.

This symbol on the battery indicates that the battery is to be collected separately.

This battery is designed for separate collection at an appropriate collection point.



1 INTRODUCTION

Thank you for buying HUBSAN products. The X4 quadcopter is designed as an easy-to-use, full-featured RC model, capable of hovering and aerobatic flight maneuvers. Please read the manual carefully and follow all the instructions. Be sure to retain the manual for future reference, routine maintenance and tuning.

2 SAFETY NOTES

2.1 Important Notes

This RC quadcopter is not a toy.

Any improper use of this product will result in serious injury. Be aware of your personal safety, safety of others and your surrounding environment.

We recommend beginners learn to fly with more experienced pilots before attempting to fly the X4 for the first time.

2.2 Caution

The X4 quadcopter has parts that move at high speed, which poses a certain degree of danger.

Choose a wide open space without obstacles. Do not operate the X4 near buildings, crowds of people, high voltage cables, or trees to ensure the safety of yourself, others and your model.

Improper operation may cause damage to people and property.

2.3 LiPo Battery Safety Notes

The X4 is powered by a Lithium-Polymer (LiPo) battery.

If you do not plan to fly the X4 for a week or more, store the battery approximately 50% charged to maintain battery performance and battery life.

H107C+ SPARE PART CHART



H107C+-01
Body shell set



H107C+-02
Battery set

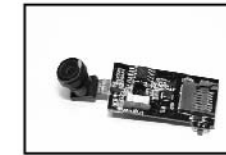

H107C+-03
HD camera module



H107C+-04
Linkage cables



H107C+-05
Screw set



H107D+-02
Propeller set



H107D+-03
Motor set



H107D+-05
Blue LED

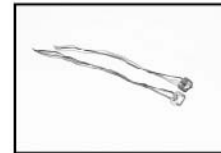

H107D+-06
Red LED



H107D+-07
Receiver PCBA board

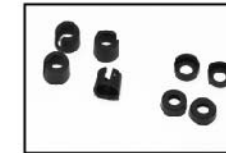

H107D+-10
Motor sleeve set

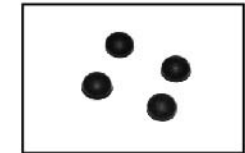

H107D+-11
Rubber feet



H107D+-14
X4 charger



H107-A11
Rubber feet



H107C+-06
Crash pack



H107C+-08
LiPo battery charger



H107C+-07
Transmitter

3) Pull the Throttle stick fully down and move the Rudder stick to the lower right position. Quickly move the Aileron stick to the left and right repeatedly until the LED lights blink, indicating successful calibration. This calibration will reduce excessive drifting when doing level yaw turns.

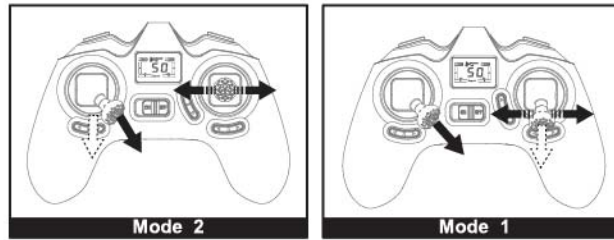

4) If the X4 still drifts to one side, add a few sheets of paper (the number of sheets will vary depending on the amount of drift) to the side of the X4 that drifts. The paper will help counterbalance and create a level offset angle.

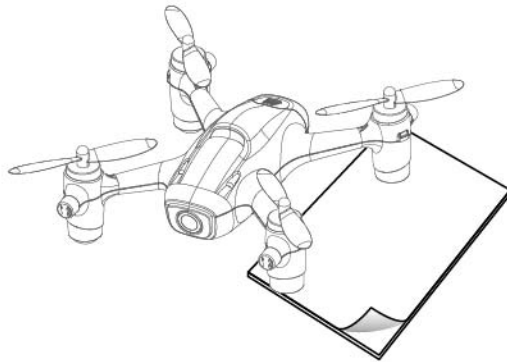

13. The camera can't record.

- 1) The SD card can't be read by the X4, use brand HD SD card (2-16G, class 4-6). Don't use any copycat SD card.
- 2) The camera module is un-functional, change a new camera module.



SAFETY ADVISORY NOTICE

Lithium-Polymer (LiPo) Batteries

LiPo batteries are different from conventional batteries in that their chemical contents are encased in a relatively lightweight foil packaging. This has the advantage of significantly reducing their weight but it does make them more susceptible to damage if roughly or inappropriately handled. As with all batteries, there is a risk of fire or explosion if safety practices are ignored:

- Charge and store LiPo batteries in a location where a battery fire or explosion (including smoke hazard) will not endanger life or property.
- Keep LiPo batteries away from children and animals.
- Never charge the LiPo battery that has ballooned or swelled.
- Never charge the LiPo battery that has been punctured or damaged.
- After a crash, inspect the battery pack for signs of damage. Discard in accordance with your country's recycling laws.
- Never charge the LiPo battery in a moving vehicle.
- Never overcharge the LiPo battery.
- Never leave the LiPo battery unattended during recharging.
- Do not charge LiPo batteries near flammable materials or liquids.
- Ensure that charging leads are connected correctly. Reverse polarity charging can lead to battery damage or a fire or explosion.
- Have a suitable fire extinguisher (electrical type) OR a large bucket of dry sand near the charging area. Do not try to extinguish electrical (LiPo) battery fires with water.
- Reduce risks from fire/explosion by storing and charging LiPo batteries inside a suitable container.
- Protect your LiPo battery from accidental damage during storage and transportation. (Do not put battery packs in pockets or bags where they can short circuit or can come into contact with sharp or metallic objects.).
- If your LiPo battery is subjected to a shock (such as a crash), place it in a metal container and observe for signs of swelling or heating for at least 30 minutes.
- Do not attempt to disassemble or modify or repair the LiPo battery.

2.4 Prevent Moisture

The X4 contains many precision electrical components.

Store the battery and the X4 in a dry area at room temperature. Exposure to water or moisture may cause malfunction resulting in loss of responsiveness, or a crash.

2.5 Proper Operation

For safety, only use the included HUBSAN spare parts for replacement.

2.6 Always Be Aware of the Rotating Blades

When in operation, the rotor blades will be spinning at high speed. The blades are capable of inflicting serious injury or damage to property.

Be careful to keep your body and loose clothing away from the blades. Never take your eyes off the X4 or leave it unattended while it is turned on. Stop operating immediately if the X4 flies out of your view. Once landed, immediately turn off the X4 and transmitter.

2.7 Avoid Flying Alone

Beginners should avoid flying alone when learning flight skills. We recommend flying with an experienced pilot nearby in case you need help.

3 SAFETY CHECKS BEFORE FLYING

CAREFULLY INSPECT THE X4 BEFORE EVERY FLIGHT

- Before operating, check that the batteries of the transmitter and X4 are charged for the flight.
- Before turning on the transmitter, check that the throttle stick is pulled completely backwards (down position).
- Carefully check rotor blades and rotor holders. Broken parts will pose a risk of injury and hazard.
- Check the battery and power plug are securely fastened. Severe vibration during flight may detach the plug and result in loss of control.
- When turning on the unit, always turn on the transmitter first and then turn on the X4. To power off, always turn off the X4 first and then the transmitter. Improper procedure may cause loss of control of the quadcopter.

9. Removing and installing LEDs

Removal: Unscrew and remove the upper shell and the motors. Then desolder the thinner LED wires.

Installation: Solder the red/ blue wire onto the anode/positive (+) lead of the LED and the black wire onto the cathode/negative (-) lead of the LED. Press the LED wires into the leg slots, then press the motor wires into the leg slots. Install the upper shell by screws. You can tell apart the color of the LED lights by the color of the LED wire: red wire is the red LED, blue wire is the blue LED.

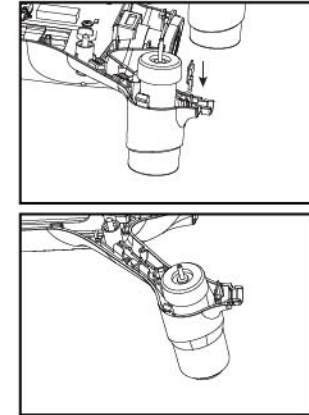
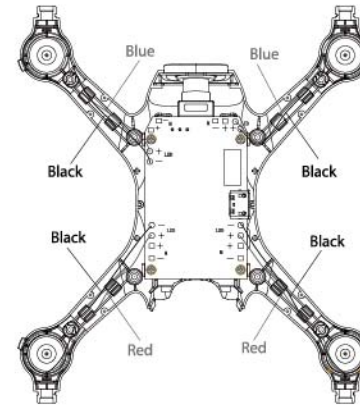

10. The motors do not spin freely after a crash.

Press the shaft down from the top of the propeller and motor to remove any objects, or replace the motor.

11. One or more motors stop working.

- (1) Spin the propellers to see if it jammed the motors, make sure the propellers can spin normally.
- (2) Resolder any broken motor connections.
- (3) Replace the motor.

12. The X4 always drifts to one direction.

Calibrate the accelerometer as follows:

- 1) Before calibrating the accelerometer, make sure that the propellers, motors and body are in good condition with the battery fully charged. Ensure that the battery inserted into the battery compartment correctly (see the picture on P10 ,7.1.2). Pair the X4 and transmitter, then put the X4 in Expert Mode.
- 2) Set both the aileron and elevator trim to the middle so that the LCD displays 50.

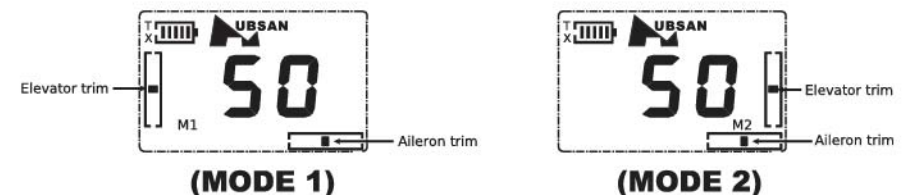

1. Transmitter and X4 do not pair.

Close the Transmitter to the X4 during binding. Make sure you do not move the transmitter sticks or trim during initial power-on.

2. Transmitter LED suddenly goes out.

Replace the AAA batteries in the transmitter.

3. Transmitter display is not showing the setting interface after holding down the Elevator stick for 2 seconds.

The throttle stick needs to be in the fully down position.

4. Gyro is not working well.

- (1) Battery voltage is too low.
- (2) Pair the X4 with the transmitter again.
- (3) Land the X4 with the throttle stick in the fully down position for 3 seconds and then take off again.

5. X4 won't perform flips.

- (1) Press and hold down the throttle stick for 1 seconds to enter into flip mode. Do the flip when the transmitter "beeps".
- (2) LiPo power is too low. Recharge the X4.

6. Quadcopter is shaking and making noise.

Check that the motors, canopy, body and propellers are all properly positioned.

7. Switching between low and high rates on the transmitter is difficult.

Press the elevator stick briefly to switch between the Expert Mode ("Expert" will also appear at the bottom center of the transmitter screen) and Normal Mode.

8. Cannot take off.

- (1) Make sure the propellers are installed correctly. The propellers are marked with "A" (clockwise) and "B" (counterclockwise). Refer to the Top View picture below for the correct orientation.
- (2) Make sure that each motor is installed correctly. There are two different motors with different motor wire colors. Refer to the Bottom View picture below for the correct order.

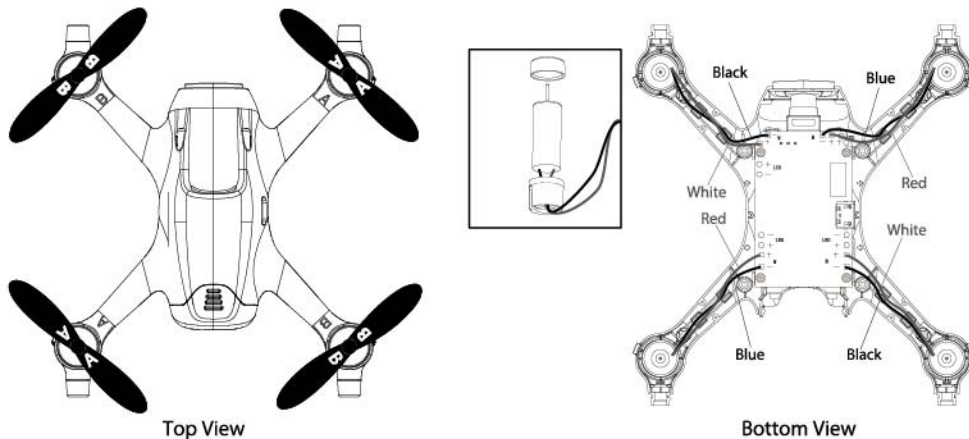

4 CHARGING THE LiPo BATTERY

4.1 3.7V 520mAh LiPo Battery

Method: Connect the X4 USB slot with USB charger, then connect the USB charger to a computer or other USB connector, such as a smartphone charger. The LED lights up while charging and turns off when charging is complete.

The voltage of the USB is $+5\pm 0.5V$.

The charging time is around 80mins and the flying time is around 7mins.

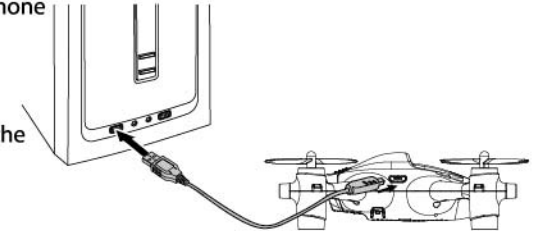

1. Take out the battery with the battery compartment when you storage it.
2. Always power off the quadcopter when you charge the battery.

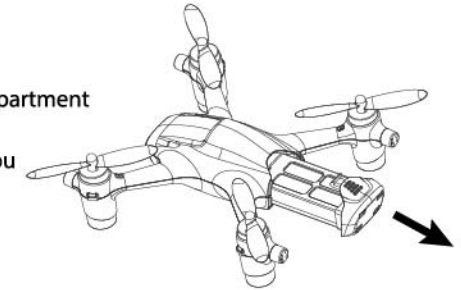

4.2 Safety Advisory Notice

Always partially charge your LiPo battery before storage. LiPo batteries retain the power over a reasonable period. It is not normally necessary to recharge stored LiPo batteries unless stored for periods longer than 3-6 months.

If your LiPo battery has been over-discharged, it will not be possible to recharge it again.



LiPo Battery Disposal & Recycling



Lithium-Polymer(LiPo) batteries must not be placed in with household trash. Please contact your environmental or waste agency or the supplier of your model for local regulations and the location of your nearest LiPo battery recycling center.

5 TRANSMITTER

5.1 Identification and Functions of the Main Menu

Main Menu

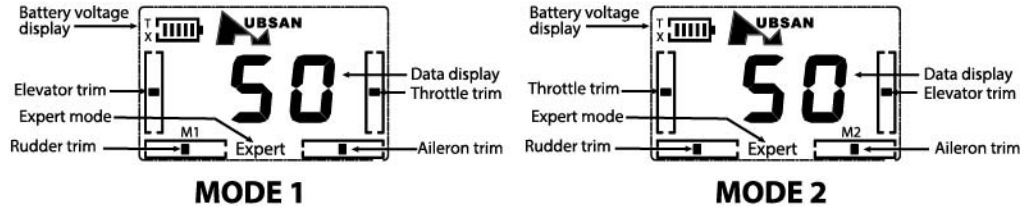

TRANSMITTER

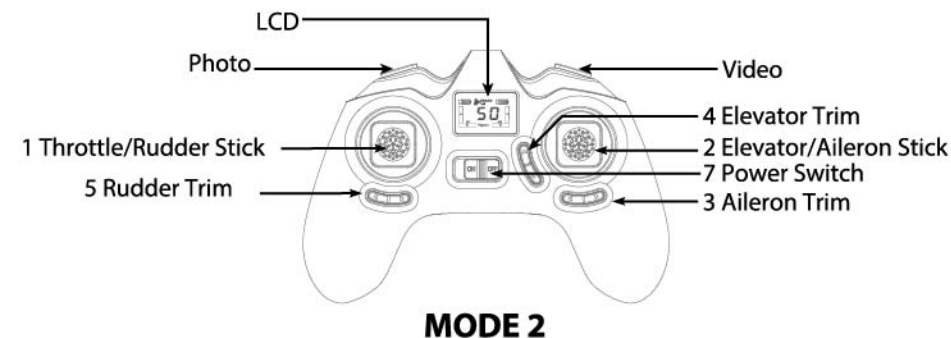
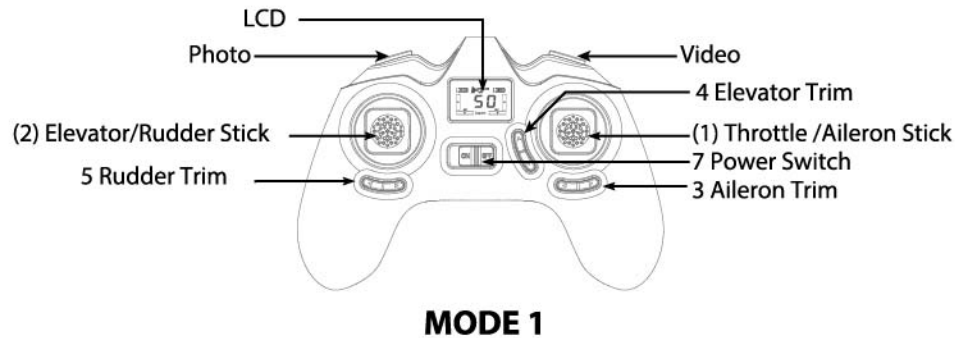

No	PART NAME	QTY	No	PART NAME	QTY
1	RX	1	13	Camera cap	1
2	720P Camera PCB module	1	14	Battery compartment	1
3	820 motor (clockwise)	2	15	Battery compartment cover	1
4	820 motor (counterclockwise)	2	16	Lower shell	1
5	LiPo battery	1	17	Upper shell	1
6	Red LED	2	18	Motor upper rubber set	4
7	Blue LED	2	19	Motor lower rubber set	4
8	Black blade A	2	20	Screw	1
9	Black blade B	2	21	Screw	4
10	Barometer sponge	1	22	Screw	8
11	Transparent lampshade	4			
12	Transparent LED hood	2			

Exploded View

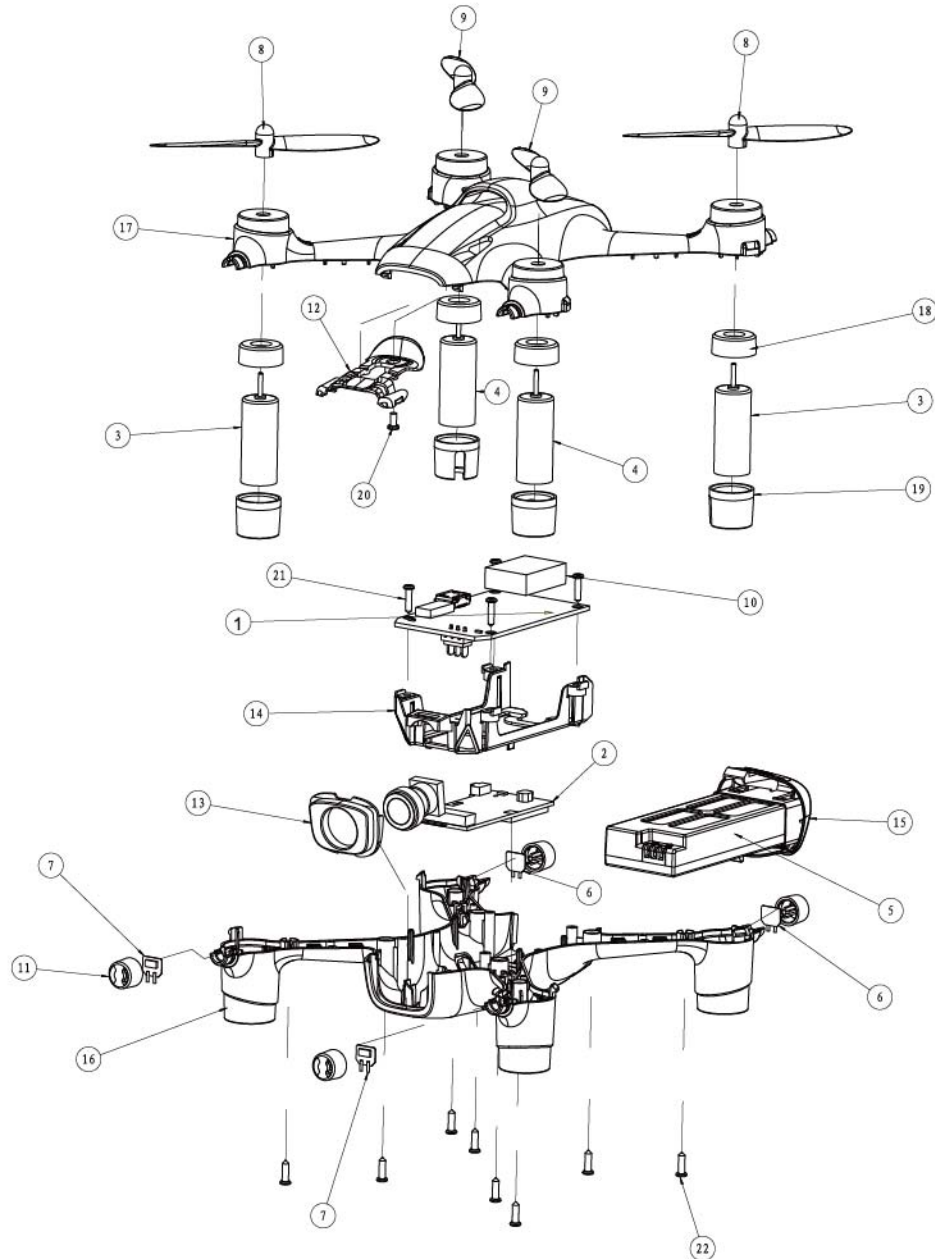

Input Key Function

S/N	Mode/ Control	Function
(1)	MODE 1 Throttle /Aileron Stick	Push the Throttle Stick, the quadcopter will ascend; release the stick, the quadcopter will keep that altitude in the air; Pull the stick, the quadcopter will fall. Move the Aileron Stick left or right to make the quadcopter drift sideways left or right.
(2)	MODE 1 Elevator/Rudder Stick	Move the Elevator Stick forward or backward to make the quadcopter move forward or backward. Move the Rudder Stick left or right to make the quadcopter yaw left or right.
1	MODE 2 Throttle/Rudder Stick	Push the Throttle Stick, the quadcopter will ascend; release the stick, the quadcopter will keep that altitude in the air; Pull the stick, the quadcopter will fall. Move the Rudder Stick left or right to rotate the quadcopter's fuselage left or right.
2	MODE 2 Elevator/Aileron Stick	Move the Elevator Stick forward or backward to make the quadcopter move forward or backward. Move the Aileron Stick left or right to make the quadcopter drift sideways left or right.
3	Aileron Trim	Aileron trim adjusts for left and right drift.
4	Elevator Trim	Elevator trim adjusts for forward and backward drift.
5	Rudder Trim	Rudder trim adjusts for drift of left and right rotation or yaw.
6	Throttle Trim	Throttle trim normally left at neutral. The lower trim turns LEDs on and off.
7	Power Switch	Push to ON to turn on the transmitter. Push to OFF to turn off.
8	Photo/ Video	Press photo button to shoot a photo; Press video button to start recording videos, press again to stop the recording.

5.2 Transmitter Stick Calibration

Mode 2: Push both sticks to the upper left position and hold. Then power on the transmitter. Rotate both sticks twice. Hold down any trim until the LED on the transmitter blinks red, indicating a successful calibration.

Mode 1: Push the left stick to the upper left position and right stick to the upper right position and hold, then power on the transmitter. Rotate both sticks twice. Hold down any trim until the LED on the transmitter blinks red, indicating a successful calibration.

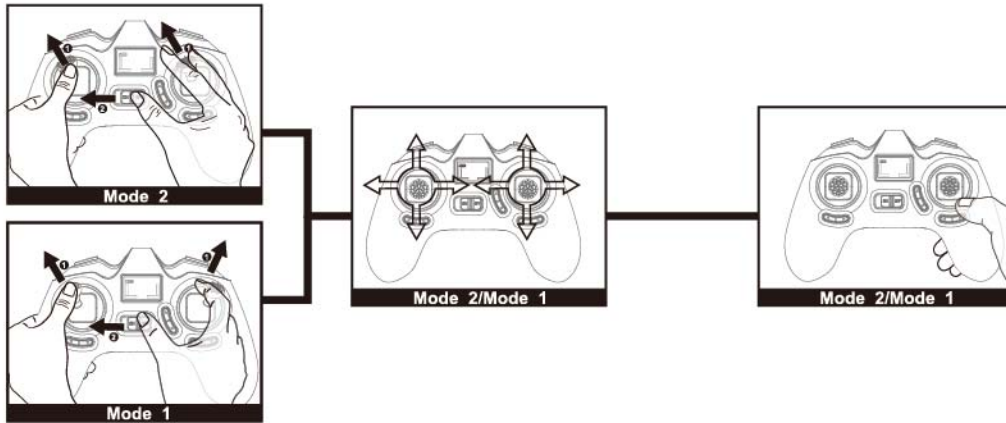

You can change the mode as you like by following the above method.

5.3 Transmitter Battery Installation

Notice: Do not mix old and new batteries.

Do not mix different types of batteries.

Do not charge non-rechargeable batteries.

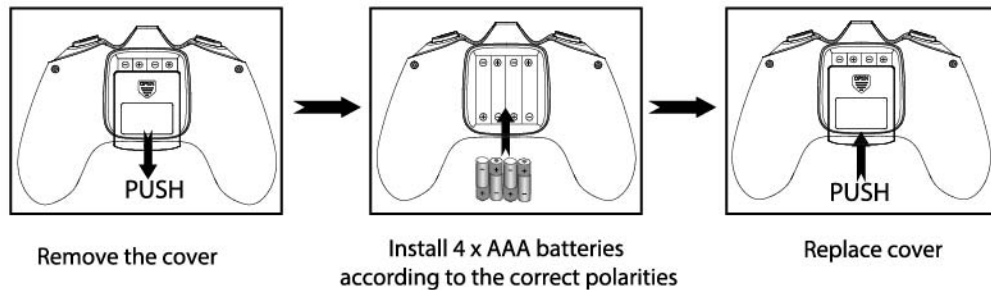

Note: When the X4 battery is low, performing flip is not possible.

9 REPLACING PROPELLERS

The X4's propellers are not identical. Each propeller is labeled with an A or B. When installing replacement propellers, be sure to install as shown below. The X4 will not fly but will flip and crash if the propellers are not installed correctly.

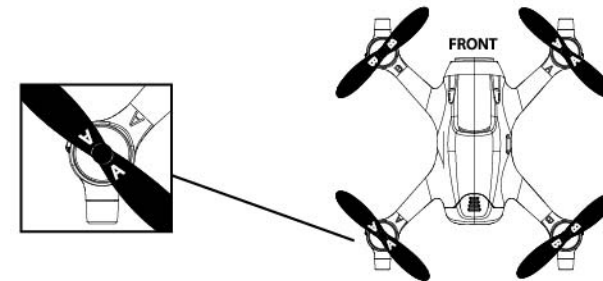

Remove Propellers: Hold the propeller, insert the U wrench under the propeller, pull up and the propeller will easily come off the motor shaft.

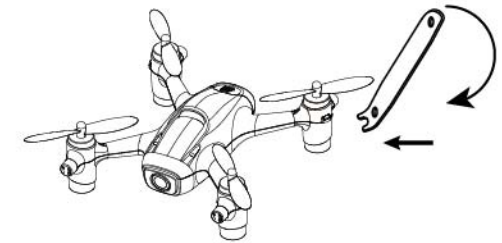

Install Propellers: Pinch the propeller hub, align the hole to the motor shaft and press it straight down firmly but gently.

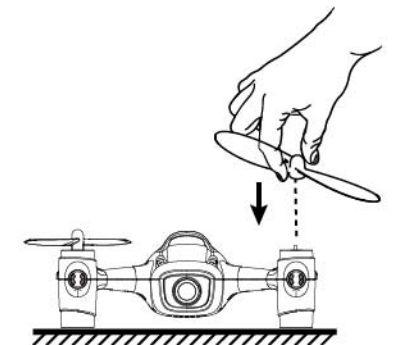

8.4.2 Right Flip

Push the Aileron stick to the right. Release the stick to the center after the flip.

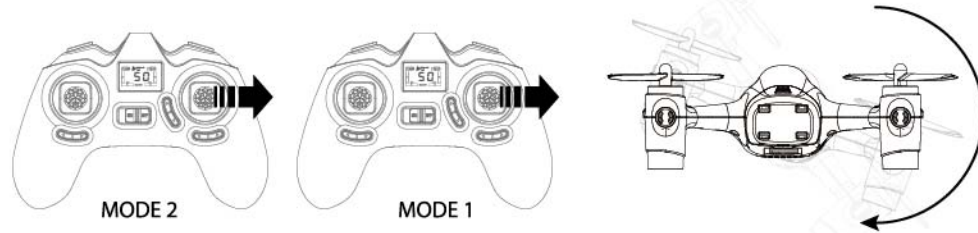

8.4.3 Forward Flip

Pull the Elevator stick forward. Release the stick to the center after the flip.

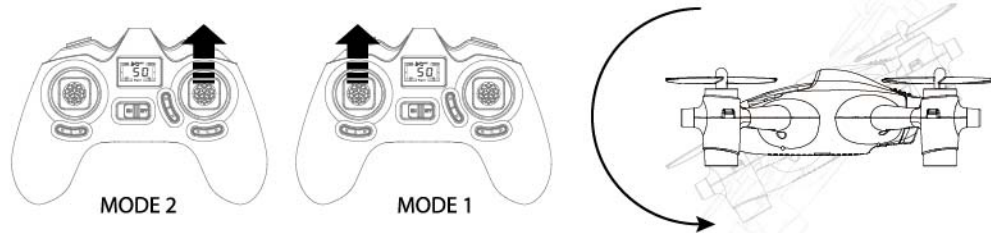

8.4.4 Backward Flip

Push the Elevator stick backward. Release the stick to the center after the flip.

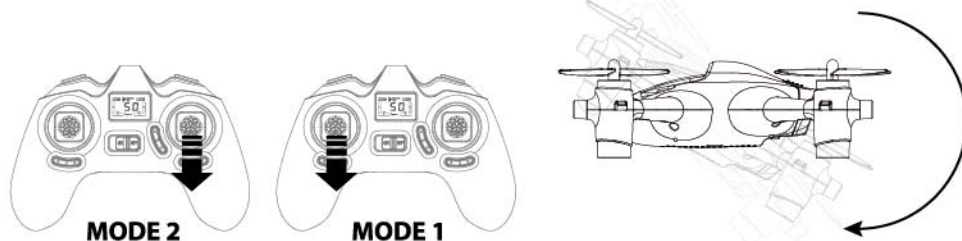

6 720P CAMERA RECORDING

6.1 Use X4 power button to record videos:

6.1.1 When the transmitter and X4 are paired, the red and blue lights situated inside the SD card slot will both come on. The camera may take several seconds to recognise the SD card. When the red light goes off, the X4 is ready to record.

6.1.2 Press the button on the side of the quadcopter (near the SD card slot) to start recording. A red light inside the SD card slot will blink and the two red LEDs on the X4 will blink alternately when recording started.

6.1.3 Press the button again to stop recording. The red lights will stop blinking and the video will be saved.

***Press the power button for 2 seconds will power off the X4.**

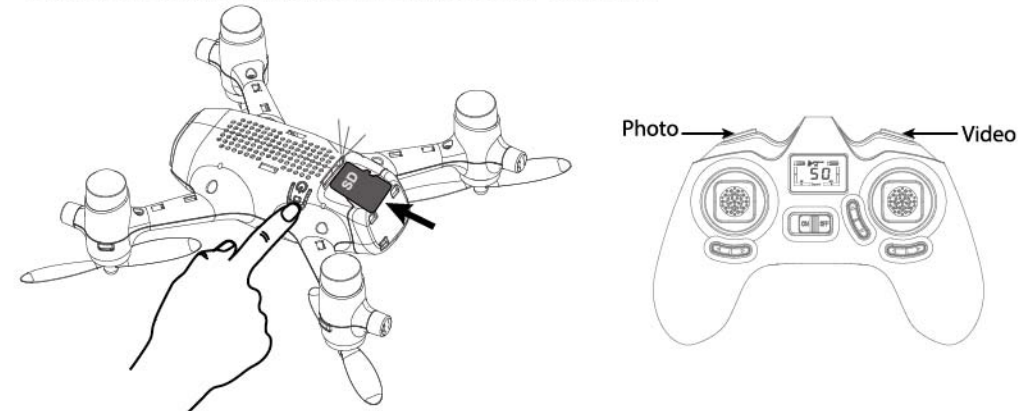

6.2 Use transmitter button to record videos/ take photos:

You can also start the recording/ take photos by using the button on the transmitter, see below.

6.2.1 Press the left button on the top of the transmitter to shoot a photo. The red LEDs on the X4 will blink one time;

6.2.2 Press the right button on the top of the transmitter to start recording videos. The red LEDs on the X4 will blink alternately. Press again to stop the recording.

***Power off both the transmitter and the X4 before inserting or removing the SD card.**

***If you don't want to save the video, just power off the quad copter before you press the button again.**

7 FLY THE X4

7.1 Power-On Safety Mode

Your X4's flight controller is designed with a Power-On safety feature that ensures that the X4's motor will not start unless it detects a suitable control signal when the LiPo battery is connected.

7.1.1 Power on the transmitter and the screen will show data. Do not move any other stick or trim before the transmitter and X4 had finished pairing, or the X4 will drift.

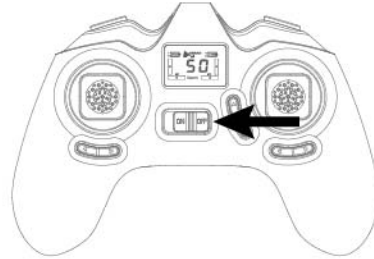

7.1.2 Press the power button under the quadcopter. Make sure the battery compartment pushed into the bottom. Put the X4 on a level surface before flight, or the X4 will drift.

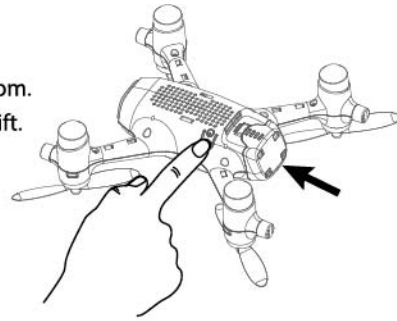

7.1.3 LED Indicators

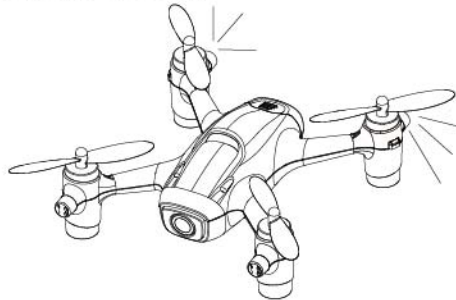

After a "beep", the red LED lights on the X4 turn steadily, indicating successful pairing.

Low Battery Alarm: The two red LEDs will blink at the same time and the X4 will descend and land down automatically to 5meters or lower from the takeoff point when the X4 battery is low.



You can also adjust sensitivity in Expert Mode following the Normal Mode procedure controls.



-  3 dots displayed in Normal (Sensitivity range 20-60%)
-  5 dots displayed in Expert (Sensitivity range 60-100%)

Press the Elevator stick to switch between Normal Mode and Expert Mode at any time.

8.4 Aerial Flip

Press and hold down the Throttle stick for 1 second to enter Flip Mode, indicated by "beeps". The beeps will last for 2 seconds. In this 2 seconds, push the accordance sticks to perform the flips.

8.4.1 Left Flip

Push the Aileron stick to the left. Release the stick to the center position after the flip.

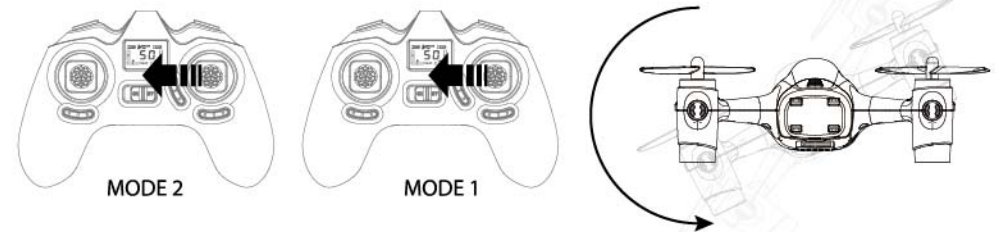

The LCD will display EXPERT when in Expert Mode.

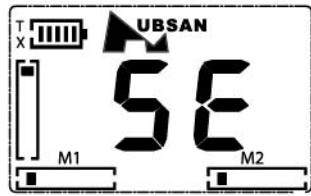

Normal mode

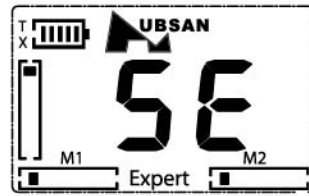

Expert mode

8.3 Sensitivity Setup

Pull the throttle stick to the lowest position. Hold down the Elevator stick for 1 seconds to enter the setup (SE) menu. Press the base of the throttle stick and the three-point dotted line starts to flash (see picture (a) below). Press it again to switch to different channels. Use the (a) Rudder Trim, (b) Elevator Trim, or (c) Aileron Trim to change the sensitivity values shown on the LCD and then hold down the Elevator stick for 2 seconds to confirm or exit. The X4 control sensitivity increases with higher value.

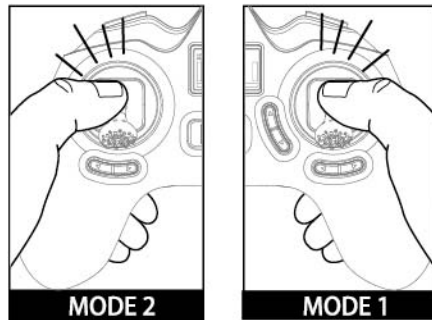

MODE 2

MODE 1



(a) Rudder Sensitivity Adjustment

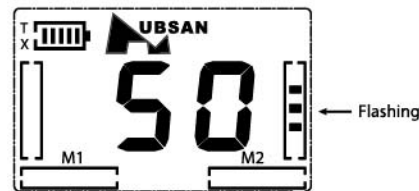

(b) Elevator Sensitivity Adjustment

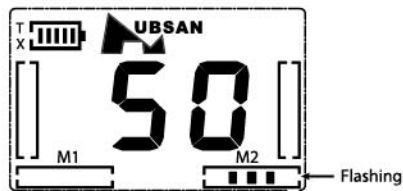

(c) Aileron Sensitivity Adjustment

7.2 Headless Mode

Headless mode means the X4 will default any direction as its head in front of the transmitter. The blue lights on the X4 will blink and a star icon shows on the LCD screen when the X4 is in headless mode.

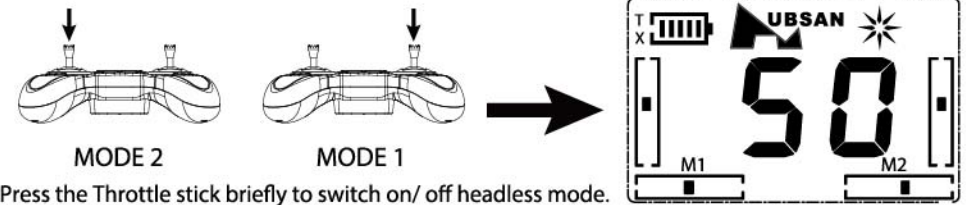

Press the Throttle stick briefly to switch on/ off headless mode.

Press the Throttle stick to enter headless Mode, indicated by two "beeps". Press the Throttle stick again to exit headless Mode, indicated by one "beep".

7.3 Transmitter Sticks And X4 Control Responses

CAUTION: To avoid loss of control, always move the transmitter sticks slowly. Be aware that control inputs will reduce available lift. Wait a few seconds for the X4 to recover the height.

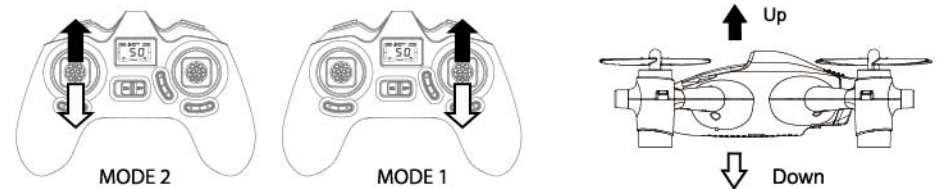

Throttle increases/decreases the flying height of your quadcopter. **This quadcopter can hold the altitude in the air.**

Method: Push the throttle stick up and the quadcopter will rise; Release the stick to the central position, the quadcopter will hover automatically and hold its altitude; Pull the stick down and the quadcopter will fall.

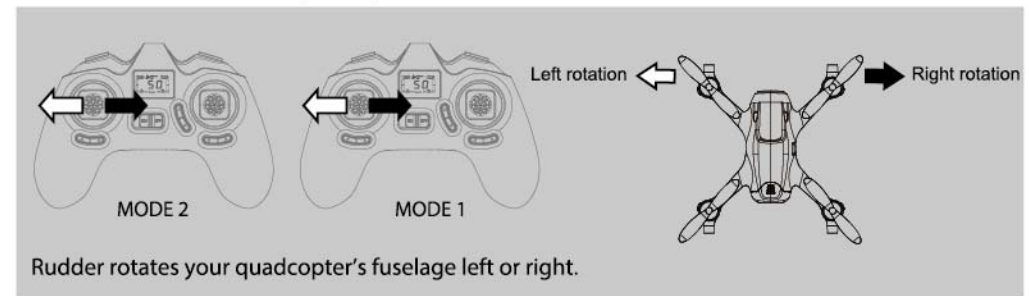

Rudder rotates your quadcopter's fuselage left or right.

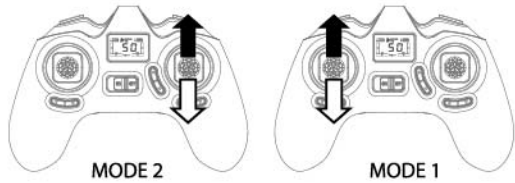

Elevator moves your quadcopter forward and backward.

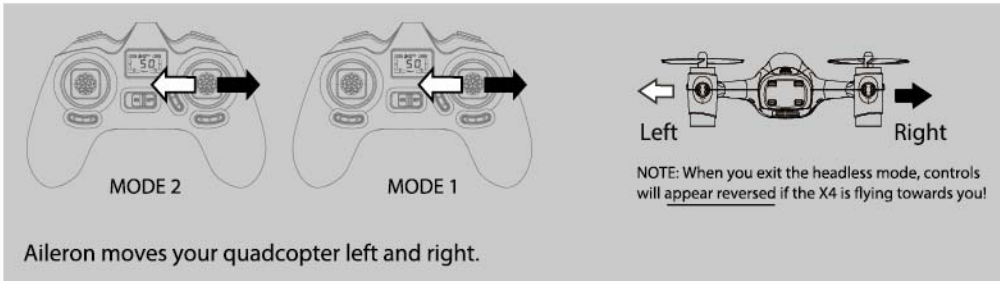
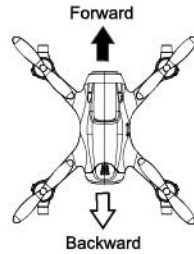

Aileron moves your quadcopter left and right.

7.4 Start/stop the motors

When you need to stop the motors quickly you can use both stickers to stop the motors.

Stop the motors

Method: Pull the two sticks again as in the picture. Release them after the motors stop.

Start the motors

Method: Pull the two sticks as the picture shows. Release them after the motors start.

Note: You can also use the throttle stick to start/ stop the motors. The X4 will ascend or descend slowly.



8 ADVANCED PERFORMANCE SETUP

8.1 Reverse Setup

8.1.1 Elevator Reverse Setup

Pull the throttle stick to the lowest position. Press and hold the Elevator stick for 1 seconds to enter the settings menu. The LCD will display "SE". Press the Elevator Trim up or down to reverse the channel and then press and hold the Elevator stick for 2 seconds to confirm and exit.

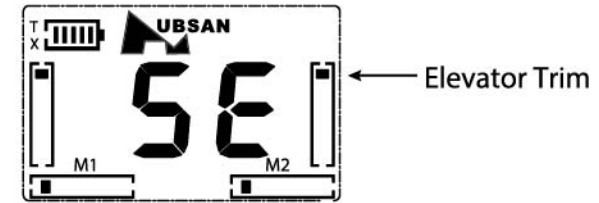

8.1.2 Aileron and Rudder Reverse Setup

Pull the throttle stick to the lowest position. Press and hold the Elevator stick for 1 seconds to enter the setting menu. Press (a) Aileron Trim / (b) Rudder Trim left or right to reverse the channel and then press and hold the Elevator stick for 2 seconds to confirm and exit.

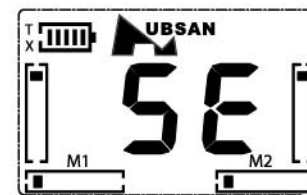

(a)Aileron Trim



(b)Rudder Trim

8.2 Normal and Expert Flight Modes

The X4 is factory set for Normal Mode flying, and it will always power up in Normal Mode. Though fast and responsive in Normal Mode, the X4 has even greater performance capability when Expert Mode is activated.

Press the Elevator stick to activate Expert Mode (the X4 and transmitter must both be on). Two beeps indicate Expert Mode; one beep indicates Normal Mode.