

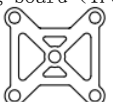

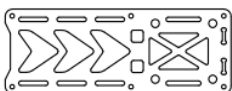

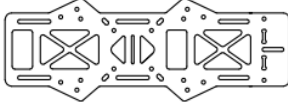

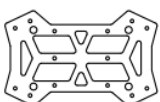

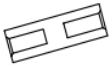
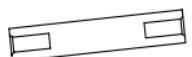

# Night Hawk 250 Frame Description

## 1. Part's list

1. Rubber shock absorption ball retaining board (1PCS) 	2. Frame upper board (1PCS) 	3. Frame center board (1PCS) 	4. Frame lower board (1PCS) 
5. Frame arm (4PCS) 	6. Camera Lens holder (1PCS) 	7. H20 Aluminum post (4PCS) 	8. H35 Aluminum post (6PCS) 
9. H5 Aluminum post (8PCS) 	10. Screw M3*8 (5PCS) 	11. Screw M3*6 (13PCS) 	12. Screw M3*18 (9PCS) 
13. Screw M2*8 (17PCS) 	14. Rubber shock absorption ball (4PCS) 	15. Self-locking nut (9PCS) 	16. Nylon screw M3*6 (5PCS) 

## 2. Frame structure diagram

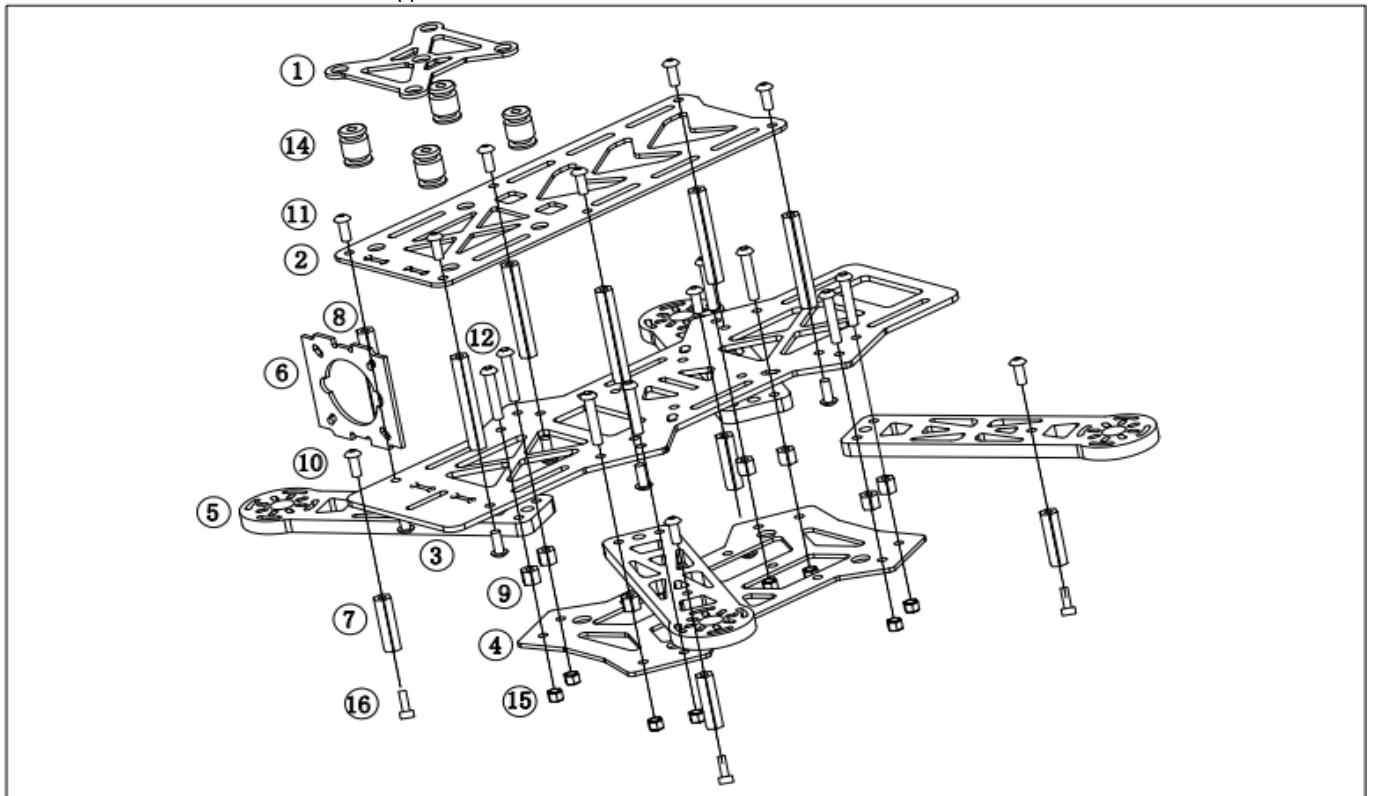

## 3. Specifications

Wheelbase: 280(+/-3mm)

Height: 74(+/-3mm)

Weight: 190g

Note: Each bag of screws and self-locking nuts contain one extra.

